

SIM LAMBDA Kabel offen SIM LAMBDA Cable open

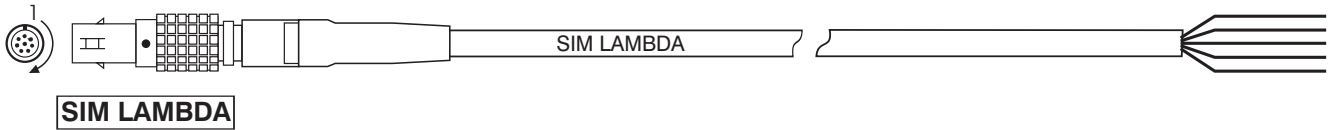

Bestell-Nr. 670-672.005 (0,5 m) 670-672.050 (5,0 m)
 Order-Nr. 670-672.015 (1,5 m) 670-672.100 (10,0 m)
 670-672.030 (3,0 m) 670-672.

670-672.



Anschlußbelegung / Connection

Lemo-Stecker 1B, 8-pol. (schwarz)
 Lemo-male 1B, 8-pol. (black)

Pin-Nr. Pin-NO	Bezeichnung Designation	Litze-Nr. / Farbe Wire-NO / Colour
1	HEATER +	1 red
2	HEATER -	2 black
3	R_CAL	3 white
4	N_CAL	4 brown
5	V_IP	5 red
6	VS +	6 black
7	VS -	7 green
8	D I/O	8 yellow
Chassis	Shield	S (Shield, thick) blue

Anschlußbeispiel / Connection example

Eingang als Spannungseingang
 Input as voltage input

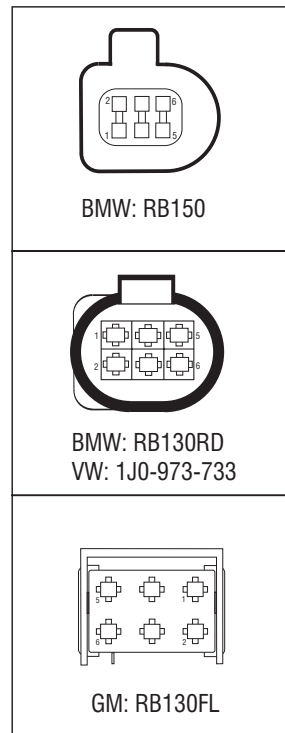
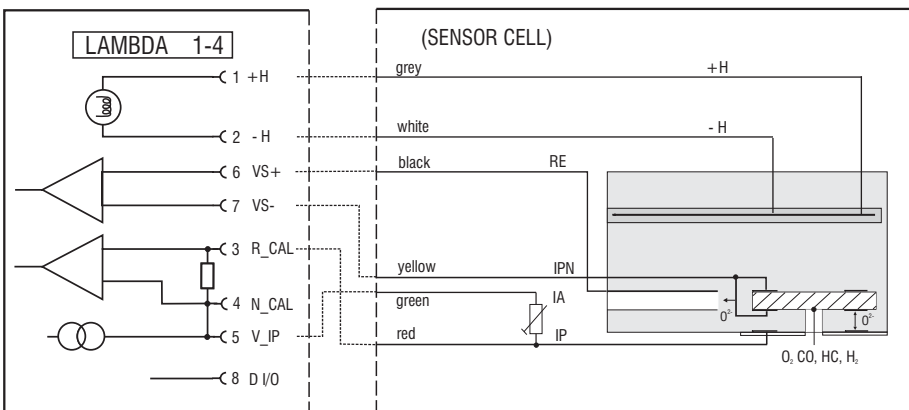

IPETRONIK	RB150	RB130	RB130fl
1 HEATER +	4 H+	4 H+	3 H+
2 HEATER -	3 H-	3 H-	4 H-
3 R_CAL	1 IP	1 IP	6 IP
4 N_CAL			
5 V_IP	5 RT	5 RT	2 RT
6 VS +	6 RE +	6 RE +	1 RE +
7 VS -	2 IPN	2 IPN	5 IPN
8 D I/O			

670-672.cdr 29.05.06 FR

Alle Rechte vorbehalten. Nachdruck und Vervielfältigung, auch auszugsweise sind verboten!